

KOXKA ICE ISLANDS

The Island Range — Greco and Van Gogh

When it comes to the KOXKA ICE island range of cases, we're giving you flexibility, as well as performance. Our islands come in two models, the Greco, a single isle model and Van Gogh, a double island. Both are ideal for the self-service sale of frozen food products. With a choice of display depths and either solid or panoramic glass, these are highly customisable cases that can be finished to your precise specifications.

There are four widths too - all ergonomically designed for optimum internal space management.

In the case of double island models, each section can accommodate chilled or frozen foods for added flexibility. The Van Gogh and the Greco are designed to increase selling performance.

Performing as good as they look

We've made several key improvements to our new island range that will please. To begin with, load capacity and footprint have been increased. In fact, tests have shown load capacity to be up by as much as 13%. Efficiency has been boosted also with a 20% cut in energy consumption. This has been achieved through innovative new air channel technology and a new evaporator, resulting in excellent product conservation.

Greco and Van Gogh are designed with continuous bumpers and optional lighting in the handrail for improved looks and visibility. A hidden kick-plate is included to eliminate unsightly joints for a better finish.

And, when it comes to maintenance, access to components is easier than ever.

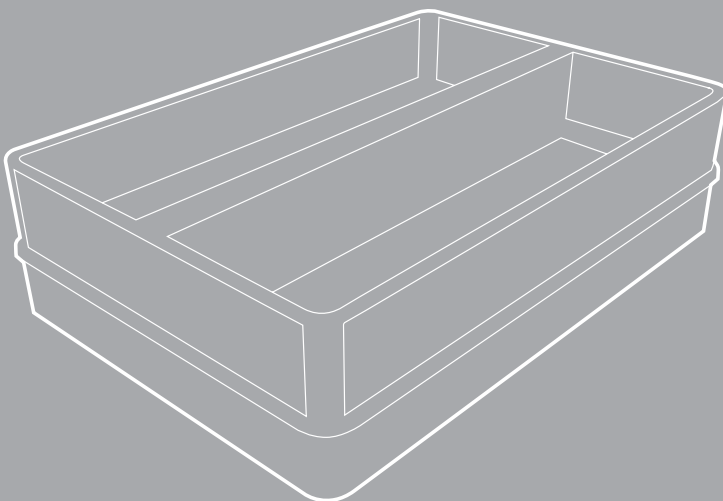

- INCREASED INTERNAL VOLUME
- UP TO 20% ENERGY SAVING
- IMPROVED AESTHETICS
- FURTHER OPTIMISATION OF FLOOR SPACE
- THREE DISPLAY DEPTHS [600-850-1200MM]
- CHOICE OF PANORAMIC OR SOLID FAÇADE
- OR A COMBINATION OF BOTH
- OPTIONAL HANDRAIL LIGHTING
- OPTIONAL SLIDING COVERS FOR EVEN
GREATER ENERGY SAVINGS
- IMPROVED RATIO EXPOSITION DECK / FOOTPRINT



*Your customers
will see the difference*



Options & Accessories

Base deck

- Plastic divider
- Adjustable grill

Sliding doors

- Night covers
- Night blinds
- Sliding doors + handrail lighting

Interior

- Lighting glass shelf
- Ticket strip
- Superstructure

Refrigerated Options

- Hot gas defrost
- Chilled Option
- Plinth fan

Controls - Electronic control

- Probes

Other

- Special packing
- Joining Kit

As with every type of product in the KOXKA ICE range, there are a wide range of accessories and options to make your chosen island fit your needs precisely.

Options exclusive to the Van Gogh and Greco models include sliding doors for additional energy savings of up to 45%, night curtains and handrail lighting.



→ panoramic glass
400 mm



→ electronic controller



→ nightblind



→ divider

For more information on accessories and options please contact Hussmann Koxka commercial department at hussmann_koxka@eu.irco.com



Single island.

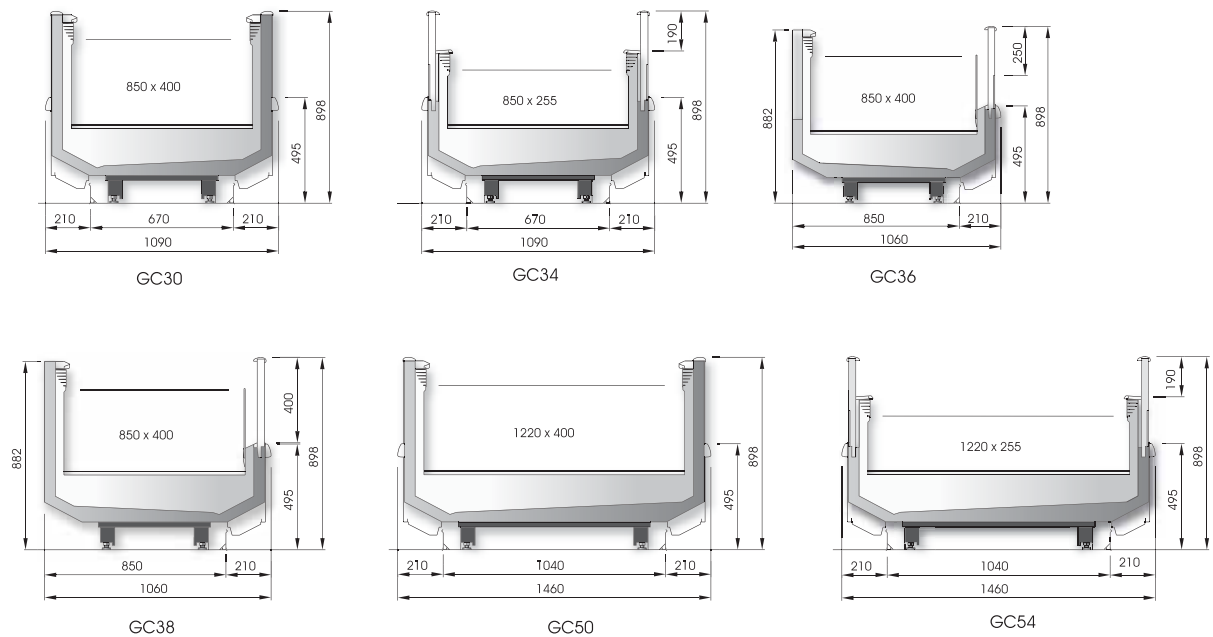

Greco	GC 30 / GC34 / GC36 / GC38					GC 50 / GC 54			
	Standard module	3	4	6	C	3	4	6	
Length [mm]		1875	2500	3750	2325		1875	2500	3750
Width 2 Sides [mm]		170	170	170	-		170	170	170
Refrigerated shelf surface [m ²]		1,594	2,125	3,188	1,845		2,288	3,050	4,575
Net Volume [lt.]	GC3*	638	850	1275	738	GC 50	913	1218	1826
	GC34	407	543	814	-	GC 54	585	780	1170
TDA – Total area display [m ²]	GC30	1,512	2,017	3,025	1,751	GC 50	2,217	2,956	4,434
	GC34	1,522	2,030	3,045	-	GC 54	2,236	2,981	4,472
	GC36	1,710	2,281	3,421	1,979				
	GC38	1,919	2,558	3,838	2,221				
Temperature range		[-23 / -25°C]					[-23 / -25°C]		
Ambient Conditions		Class 3 [25°C - 60% H.R.]					Class 3 [25°C - 60% H.R.]		



VAN GOGH

Double islands.

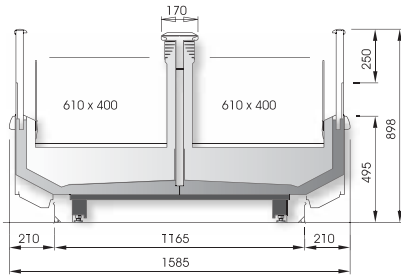

GH62

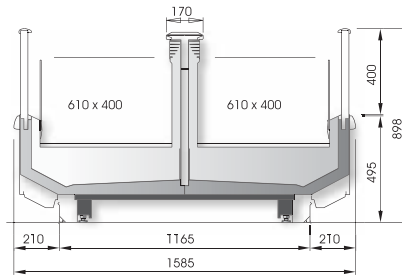

GH64

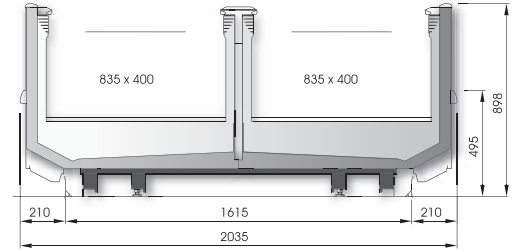

GH70

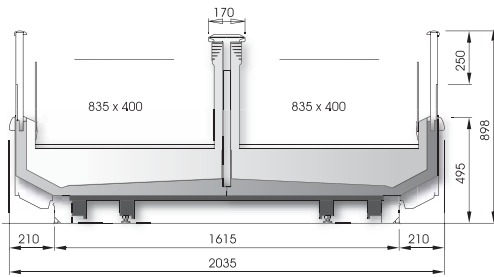

GH72

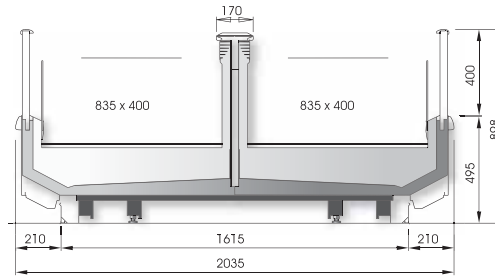

GH74

Van Gogh

	GH 62 / GH64				GH70 / GH72 / GH74					
	3	4	6	C	3	4	6	C		
Standard module	3	4	6	C	3	4	6	C		
Length [mm]	1875	2500	3750	1580	1875	2500	3750	2030		
Width 2 Sides [mm]	170	170	170	-	170	170	170	-		
Refrigerated shelf surface [m ²]	2,288	3,050	4,575	1,211	3,131	4,175	6,263	1,594		
Net Volume [lt.]	900	1200	1800	485	1238	1650	2475	638		
TDA – Total area display [m ²]	GH62	2,367	3,156	4,734	1,300	GH 70	2,984	3,978	5,968	1,512
	GH64	2,575	3,434	5,151	1,458	GH 72	3,223	4,298	6,447	1,710
						GH 74	3,432	4,576	6,864	1,919
Temperature range	[-23 / -25°C]				[-23 / -25°C]					
Ambient Conditions	Class 3 [25°C- 60% H.R.]				Class 3 [25°C- 60% H.R.]					



Full technical information is available on CD-ROM.