



INDÚSTRIA DE REFRIGERAÇÃO, LDA
Parque Industrial do Socorro
Lotes n.º 43, 44 e 45 - Quinchães
4820-571 FAFE
PORTUGAL
Tel.: (+) 351 253 595 324 Fax: (+) 351 253 598 762
mecfri@mecfri.com <http://www.mecfri.com>

VITRINA REFRIGERADA
REFRIGERATED DISPLAY CASE
VITRINE RÉFRIGÉRÉE

E6
1

PISCIS
0/+4 °C

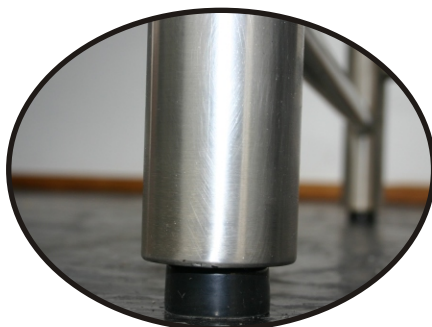
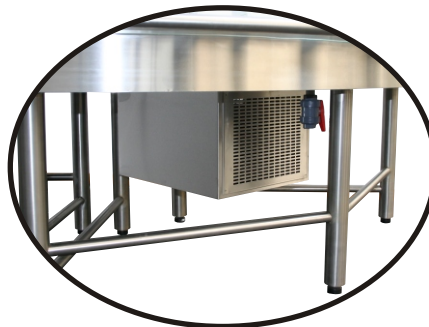

E6
2

VITRINA REFRIGERADA
REFRIGERATED DISPLAY CASE
VITRINE RÉFRIGÉRÉE

INDÚSTRIA DE REFRIGERAÇÃO, LDA

Parque Industrial do Socorro
Lotes n.º 43, 44 e 45 - Quinchães
4820-571 FAFE
PORTUGAL

Tel.: (+) 351 253 595 324 Fax: (+) 351 253 598 762
mecfri@mecfri.com http://www.mecfri.com



PISCIS

0/+4 °C

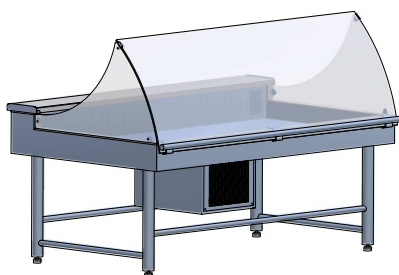

Canto esférico Exterior
Spherical Outer Corner
Angle Sphérique Extérieur



Canto esférico Interior
Spherical Inner Corner
Angle Sphérique Intérieur

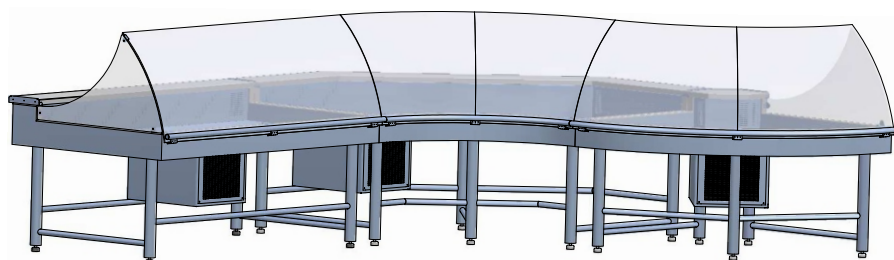
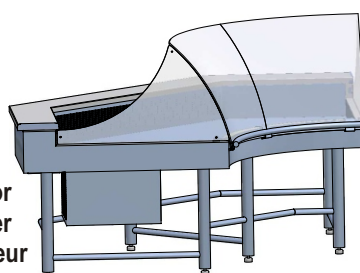

Dimensões em mm / Dimensions in mm / Dimensions en mm

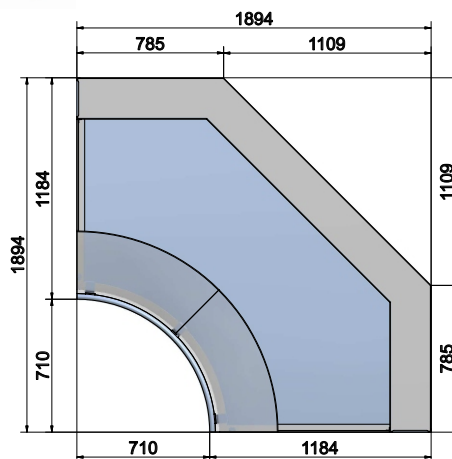
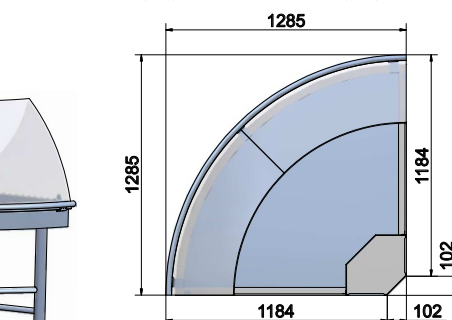
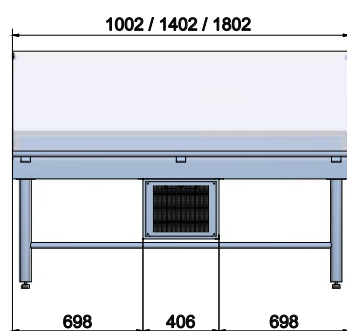
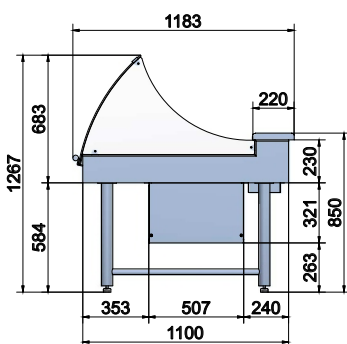

Características sujeitas a modificações sem aviso prévio / Characteristics subject to change without prior notice / Caractéristiques sujettes à modifications sans préavis

| Comprimento Length Longueur (cm) | Área Exposição Deck Area Surface Exposition (m ²) | Potência Mecânica Mechanic Power Puissance Mécanique (HP / CV / PS) | Potência Frigorífica Refrigerated Power Puissance Frigorifique (Watt / -10 °C / +35 °C) | Peso Líquido Net Weight Poids Net (Kg) | | Peso Bruto Gross Weight Poids Brut (Kg) | |
|---|--|--|--|---|----|--|----|
| | | | | FE | DS | FE | DS |
| 100,2 | 0,94 | 3/8 | 570 | | | | |
| 140,2 | 1,35 | 1/2 | 710 | | | | |
| 180,2 | 1,75 | 1/2 | 870 | 122 | | | |
| CE * | 1,01 | 1/4 | 350 | 75 | | | |
| CI ** | 2,16 | 1/2 | 870 | 159 | | | |

* CE - Canto Esférico Exterior / Spherical Outer Corner / Angle Sphérique Extérieur ** CI - Canto Esférico Interior / Spherical Inner Corner / Angle Sphérique Intérieur



CARACTERÍSTICAS CONSTRUTIVAS:

Vidro frontal curvo temperado.

Três comprimentos de vitrina disponíveis: 1,002; 1,402 e 1,802 mts.

Esgoto por torneira por baixo do tampo expositor.

CARACTERÍSTICAS TÉCNICAS:

Refrigeração estática (FE) ou duplo estático (DS).



CONSTRUCTION CHARACTERISTICS:

Curved and tempered front glass.

Three display lengths available: 1,002; 1,402 and 1,802 mts.

Tap for drainage of water from the exhibition deck.

TECHNICAL CHARACTERISTICS:

Static air refrigeration (FE) or double static (DS).



CARACTÉRISTIQUES CONSTRUCTIVES:

Vitre frontale courbe trempée.

Trois longueurs de vitrine disponibles: 1,002; 1,402 et 1,802 mts.

Écoulement des eaux du plateau d'exposition par robinet.

CARACTÉRISTIQUES TECHNIQUES:

Réfrigération statique (FE) ou double statique (DS).